

Recessed Downlight IP44

Recessed LED downlight, direct replacement for traditional 2x26W compact fluorescent downlights. Homogenously lit white opal diffuser made of TpA rated PC. High efficacy, up to 80% energy saving compared to fluorescent light sources. 220 - 240 mm cut-out diameter. AMY VARIO FLEX can be installed into a wide range of ceiling types of 2 -16mm thickness, IP44 from the room side, Impact strength: IK06. Total luminous flux: 1950 lm, Luminaire input power: 17 W, Luminaire efficacy: 115 lm/W correlated colour temperature (CCT) adjustable via switch for warm white (3000K), neutral white (3500K) or cold white (4000K) to suit application use. Lifetime: 50.000hrs @L80, Colour Rendering: CRI > 80. Chromaticity tolerance (initial MacAdam): 4. Photobiological Risk Group RG0}, THD<20%. Body: Polycarbonate, white (RAL 9003), Diffuser: Polycarbonate, TPA. Tool-free connection enabling loop-in loop-out wiring. Plug&Play with "Just Emergency E3 KIT" for 3h emergency operation. Lumen package adjustable on site by 3 steps FLEX@4000K: (FLEX1 - 1950 lm (17W), FLEX2 - 1600 lm (14W), FLEX3 - 1400 lm (12W). Detailed power setting information available on www. THORNeco.com. Dimensions: Ø250 x 82 mm, weight: 0.55 kg.

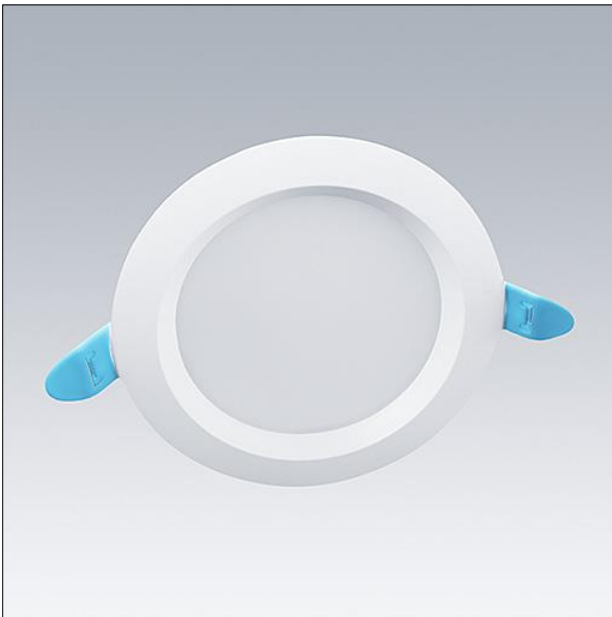

TE_AMYVF_F_PERSP.jpg

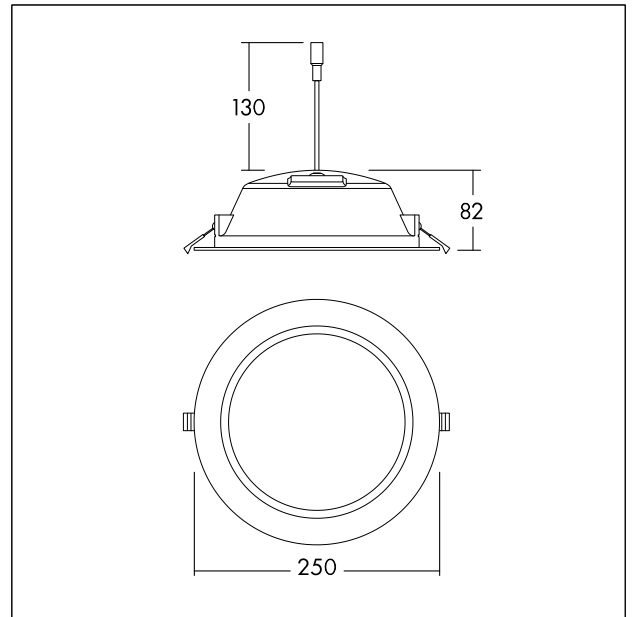

TE_AMYVF_M_220.wmf

Light Distribution

STD - standard

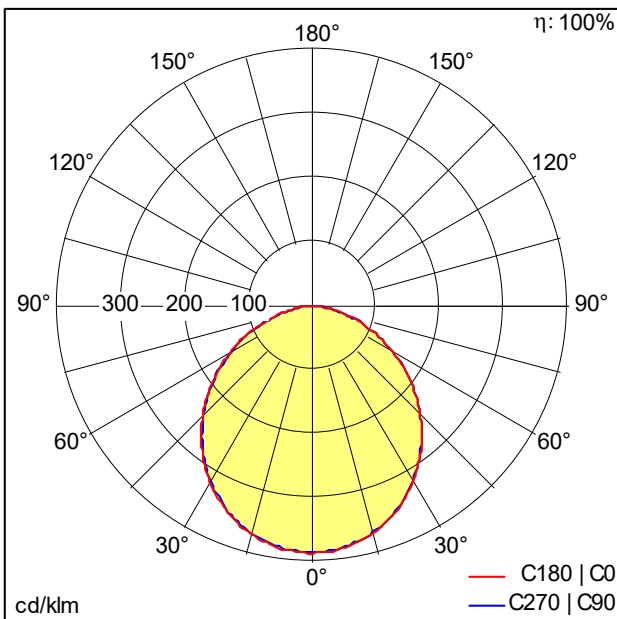

TE_AMY_VARIO_FLEX_220_1950_840_FLEX1.ltd

- Light Source: LED
- Luminaire luminous flux*: 1950 lm
- Total emergency luminous flux: 450 lm
- Luminaire efficacy*: 115 lm/W
- Colour Rendering Index min.: 80
- Correlated colour temperature*: 3000-4000 Kelvin
- Chromaticity tolerance (initial MacAdam): 4
- Rated median useful life*: L80 50000 h at 25 °C
- Ballast: 1x LED_Con
- Luminaire input power*: 17 W Power factor = 0.9
- Dimming: Fixed output
- Maintenance category CIE 97: D - Enclosed IP2X
- Total harmonic distortion (THD): 20.00 %

All values marked with an * are rated values. Connected electrical load and luminous flux are subject to an initial tolerance of +/- 10%, the most similar colour temperature is subject to an initial tolerance of +/- 150K. Unless stated otherwise, the values apply to an ambient temperature of 25°C.