

Recessed LED panel

LED Panel DALI dimmable with opal homogenous light emitting surface. Easy to adjust tuneable colour temperature switch located on the luminaire. Gentle, soft and glare-free lighting with UGR <19 for schools and offices with opal diffuser made of TpB rated PET for fully homogenous illumination and aluminium frame. Total luminous flux: 4400 lm, Luminaire input power: 36 W, Luminaire efficacy: 122 lm/W, correlated colour temperature (CCT) adjustable via switch for 3000K, 3500K or 4000K. Lifetime: 50.000hrs @L80, Colour Rendering: CRI > 80, Chromaticity tolerance (initial MacAdam): 4. DALI driver offering dimming range 1 to 100% via DALI-2 and switchDIM. DC level 15%. Mains frequency 0/50/60 Hz. Suitable for emergency escape lighting systems acc. to EN 50172. Provided with detachable quick connector for easy installation and tool-free loop-in loop-out wiring and safety wire, Flicker free, suitable for lay-in installation. Available accessories: Plug&Play Emergency kit for 3 hour emergency conversion (Self- or Manualtest), surface- and recessed mounting kit. Dimensions: 596 x 596 x 35 mm, weight: 1.37 kg. (Not DSI-compatible).

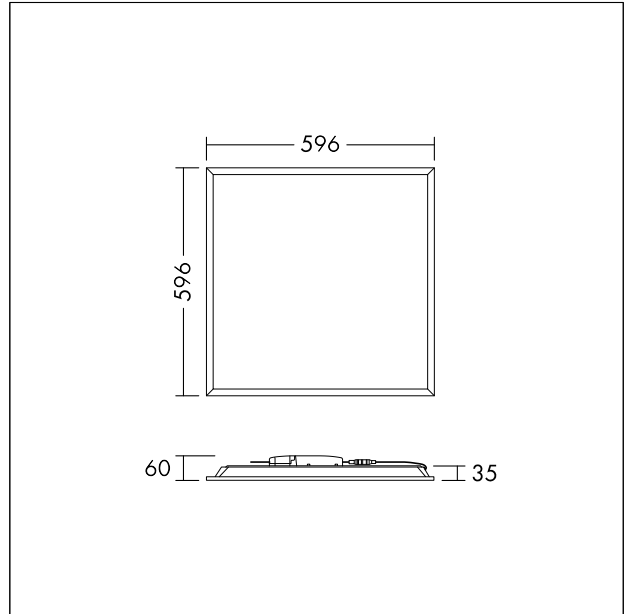

TE_ANNAVARIO_F_600_persp.jpg



TE_ANNAVF2_M_Q596.wmf

Light Distribution

STD - standard

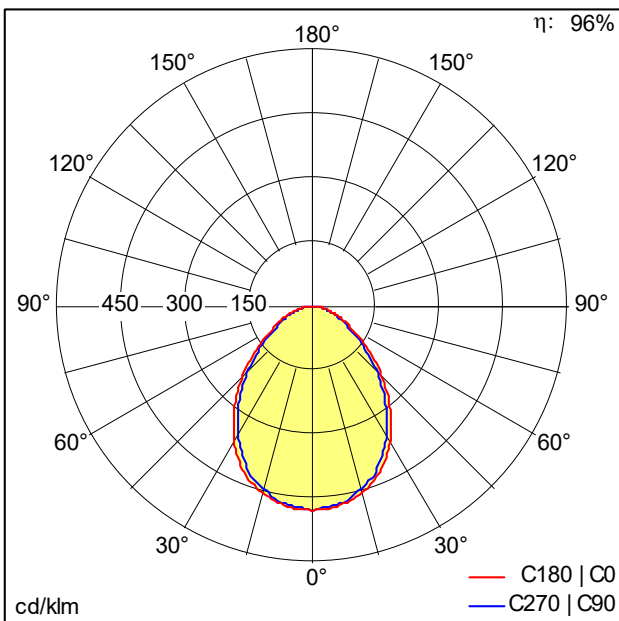

TE_ANNA_VF2_Q596_4400_840_FLEX1.ltd

- Light Source: LED
- Luminaire luminous flux*: 4206 lm
- Total emergency luminous flux: 490 lm
- Luminaire efficacy*: 117 lm/W
- Colour Rendering Index min.: 80
- Correlated colour temperature*: 3000-4000 Kelvin
- Chromaticity tolerance (initial MacAdam): 4
- Rated median useful life*: L80 50000 h at 25 °C
- Ballast: 1x LED_Con
- Luminaire input power*: 36 W Power factor = 0.9
- Dimming: HFIX dimmable to 1%
- Maintenance category CIE 97: D - Enclosed IP2X
- Total harmonic distortion (THD): 15.00 %

This product contains a light source of energy efficiency class D.

All values marked with an * are rated values. Connected electrical load and luminous flux are subject to an initial tolerance of +/- 10%, the most similar colour temperature is subject to an initial tolerance of +/- 150K. Unless stated otherwise, the values apply to an ambient temperature of 25°C.