

## High Power LED Floodlight

High Power LED Floodlight with asymmetric light distribution, FLEX technology, IP66 for outdoor applications. Luminaire input power: 120 W, Lifetime: 50.000h L80, Total luminous flux: 15000 lm. Luminaire efficacy: 125 lm/W. Colour rendering Ra > 80, colour temperature 3000 K, Chromaticity tolerance (initial MacAdam): 5, Impact strength: IK08. Climate membrane for automatic climate regulation. Surge protection 10kV. Pre-wired with mains cable (1m) including connector for easy and tool-free wiring. Integrated adjustable photocell. Corrosion class C4. Product is not suitable for chlorine environments. Body: die-cast aluminium (<0,1% copper), anthracite grey (RAL 7016), Bracket: steel, anthracite grey. Cover: Tempered glass. Input power adjustable on site by 3 step (FLEX1: 15000 lm (120W), FLEX2: 12500 lm (90W), FLEX3 - 10000 lm (70W)). For flex data on other colour temperatures please visit website. Dimensions: 330 x 419 x 56 mm, weight: 3.7 kg.

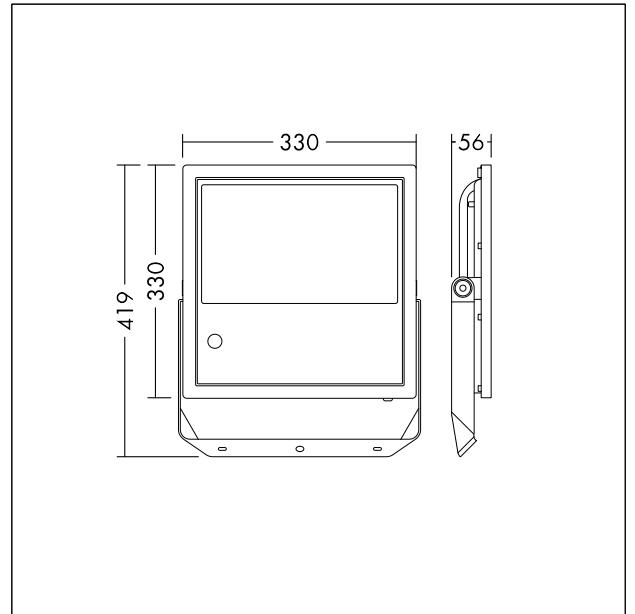

TE\_LEOFLEX\_F\_120\_front.jpg



TE\_LEOFLEX\_M\_120.wmf

## Light Distribution

STD - standard

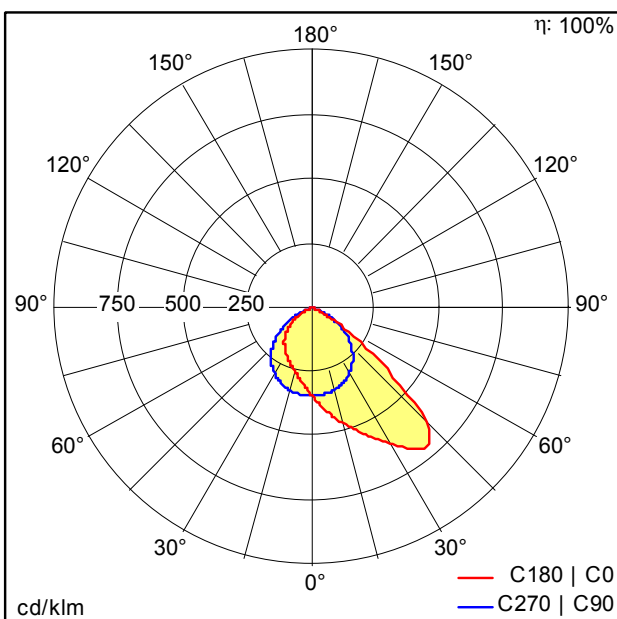

TE\_LEO\_FLEX\_120W\_830\_FLEX1.idt

- Light Source: LED
- Luminaire luminous flux\*: 15015 lm
- Luminaire efficacy\*: 125 lm/W
- Colour Rendering Index min.: 80
- Correlated colour temperature\*: 3000 Kelvin
- Chromaticity tolerance (initial MacAdam): 5
- Rated median useful life\*: L80 50000h at 25°C
- Ballast: 1x LED\_Con
- Luminaire input power\*: 120 W Power factor = 0.91
- Dimming: Fixed output
- Maintenance category CIE 97: E - Dust-proof IP5X
- Total harmonic distortion (THD): 15.00 %

This product contains a light source of energy efficiency class D.

All values marked with an \* are rated values. Leistung und Lichtstrom unterliegen initial einer Toleranz von +/- 10%, die ähnlichste Farbtemperatur unterliegt initial einer Toleranz von +/- 150K. Unless stated otherwise, the values apply to an ambient temperature of 25°C.