

LED batten

A fast install and versatile IP20 batten with press release buttons for quick opening and installation. Reliable integrated LED technology, ensuring maintenance-free installation and a long lifetime. Homogeneous illumination. Direct replacement for conventional battens in terms of light performance and length. Integrated Passive Infrared Sensor for movement detection. Piano-key terminals, enabling loop-in loop-out. ENEC certified driver.

Body: sheet steel, white finish (RAL 9002).

Diffuser: polycarbonate, opal.

End caps: polycarbonate, white (RAL 9002).

Weight: 3,6 kg



TE_POPPY_F_PIR_1500_persp.jpg

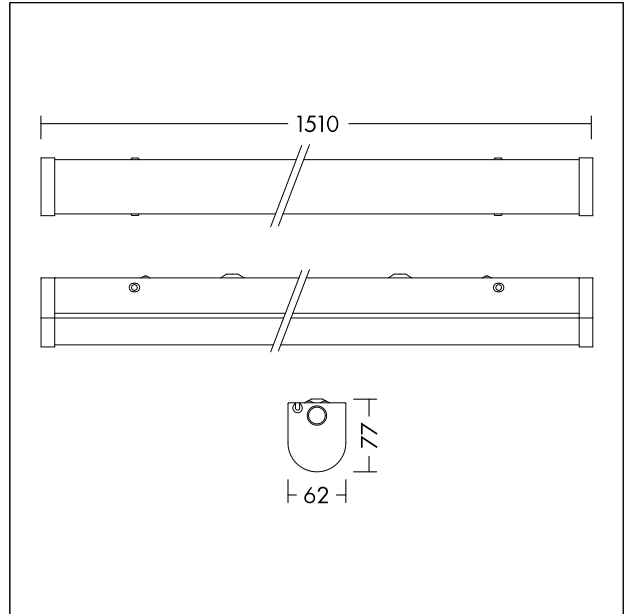

TE_POPPY_M_1510.wmf

Light Distribution

STD - standard

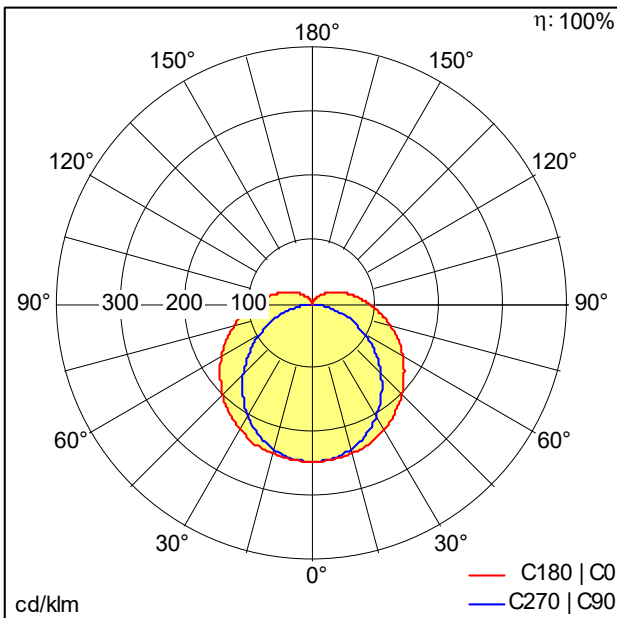

TE_POPPY_LED_1500_4500_840.idt

- Light Source: LED
- Luminaire luminous flux*: 4504 lm
- Luminaire efficacy*: 113 lm/W
- Colour Rendering Index min.: 80
- Correlated colour temperature*: 4000 Kelvin
- Chromaticity tolerance (initial MacAdam): 5
- Rated median useful life*:
 L70 50000h at 25°C
- Ballast: 1x LED_Con
- Luminaire input power*: 40 W Power factor = 0.9
- Dimming: Fixed output
- Maintenance category CIE 97: D - Enclosed IP2X
- Total harmonic distortion (THD): 15.00 %

This product contains a light source of energy efficiency class E.

All values marked with an * are rated values. Connected electrical load and luminous flux are subject to an initial tolerance of +/- 10%, the most similar colour temperature is subject to an initial tolerance of +/- 150K. Unless stated otherwise, the values apply to an ambient temperature of 25°C.