

LED Floodlight

High power LED Floodlight with asymmetrical light distribution - ideal for building facades and footpaths. Compact and streamline design. Climate membrane for automatic climate regulation inside the floodlight. Surge protection up to 10kV. Pre-wired with mains cable (3m). Integrated photocell.

Body: Aluminium die-cast (<5% copper)

Bracket: Steel, gray (RAL 9006)

Cover: Tempered glass

Lens: PC

Weight: 6,6 kg



TE_LEO_F_200.jpg

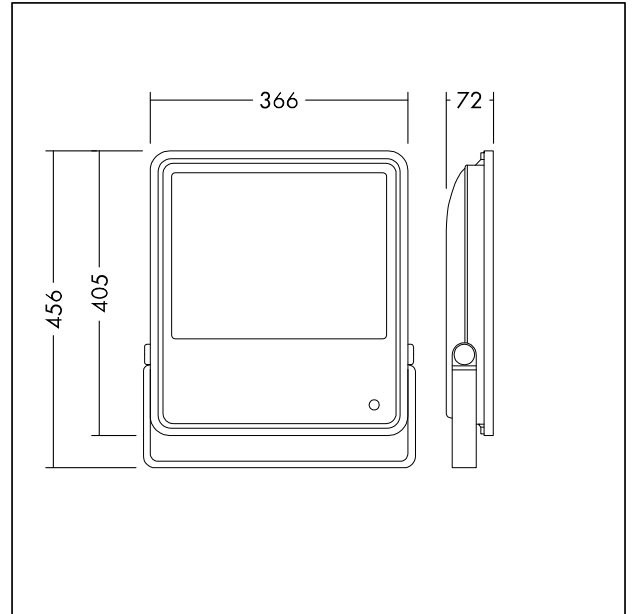

TE_LEO_M_150.wmf

Light Distribution

STD - standard

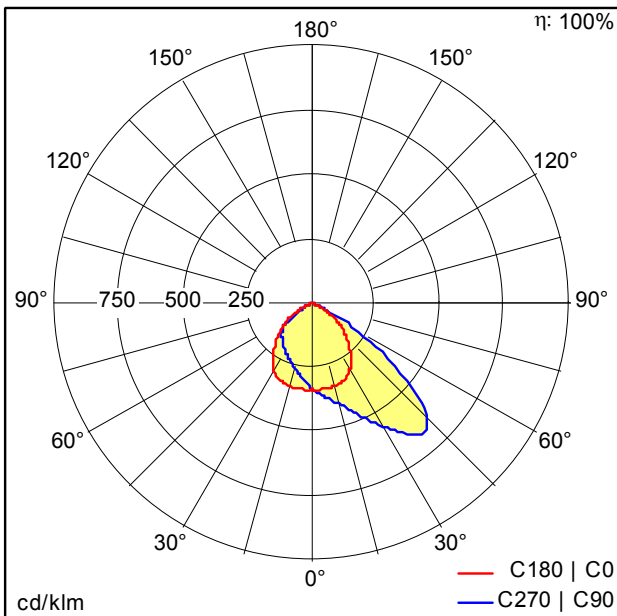

TE_LEO_LED_FL_IP66_200W_830_PC.ltd

- Light Source: LED
- Luminaire luminous flux*: 20000 lm
- Luminaire efficacy*: 100 lm/W
- Colour Rendering Index min.: 80
- Correlated colour temperature: 3000 Kelvin
- Chromaticity tolerance (initial MacAdam): 5
- Rated median useful life*:
L70 50000h at 25°C
- Ballast: 1x LED_Con
- Luminaire input power*: 200 W Power factor = 0.9
- Dimming: Fixed output

All values marked with an * are rated values. Luminous flux and connected electrical load are subject to an initial tolerance of +/- 10%. Unless stated otherwise, the values apply to an ambient temperature of 25°C.