

## LED Floodlight

High power LED Floodlight with asymmetrical light distribution - ideal for building facades and footpaths. Compact and streamline design. Climate membrane for automatic climate regulation inside the floodlight. Surge protection up to 10kV. Pre-wired with mains cable (3m). Integrated photocell.

Body: Aluminium die-cast (<5% copper)

Bracket: Steel, gray (RAL 9006)

Cover: Tempered glass

Lens: PC

Weight: 4,15 kg



TE\_LEO\_F\_100.jpg

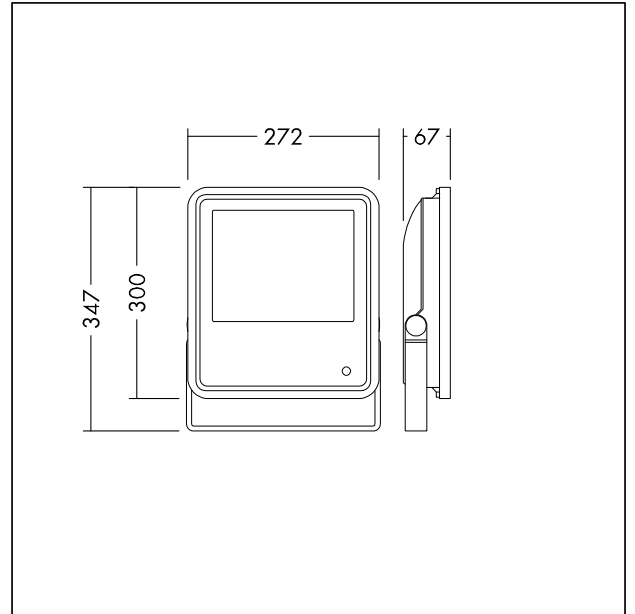

TE\_LEO\_M\_75.wmf

## Light Distribution

STD - standard

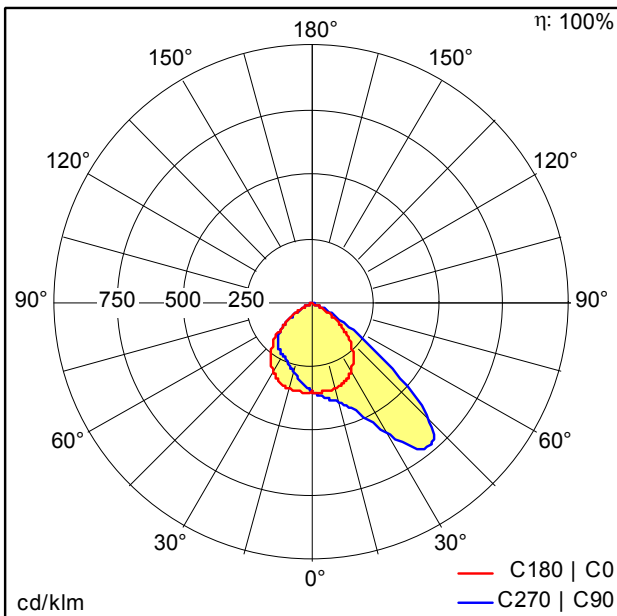

TE\_LEO\_LED\_FL\_IP66\_100W\_830\_PC.ltd

- Light Source: LED
- Luminaire luminous flux\*: 10000 lm
- Luminaire efficacy\*: 100 lm/W
- Colour Rendering Index min.: 80
- Correlated colour temperature: 3000 Kelvin
- Chromaticity tolerance (initial MacAdam): 5
- Rated median useful life\*:  
L70 50000h at 25°C
- Ballast: 1x LED\_Con
- Luminaire input power\*: 100 W Power factor = 0.9
- Dimming: Fixed output
- Total harmonic distortion (THD): 20.00 %

This product contains a light source of energy efficiency class E.

All values marked with an \* are rated values. Luminous flux and connected electrical load are subject to an initial tolerance of +/- 10%. Unless stated otherwise, the values apply to an ambient temperature of 25°C.