

Recessed downlight

Recessed downlight including white adjustable trim, light engine Colour rendering Ra > 90, colour temperature 4000 K, with 38° beam angle and connector. Highly efficient and economical downlight. Lay insulation directly over the top of the product. Tool free and fast wiring due to the fully detachable connector and the press-fit terminal block enabling loop-in loop-out. Integrated LED driver suitable for use with leading-edge dimmer switches. Choose between lots of different accessories to fit every application. Body: die-cast aluminium powder coated, black Trim: Aluminum, white, RAL9003. Lens: PMMA, Cover: PC. Weight: 0.32 kg

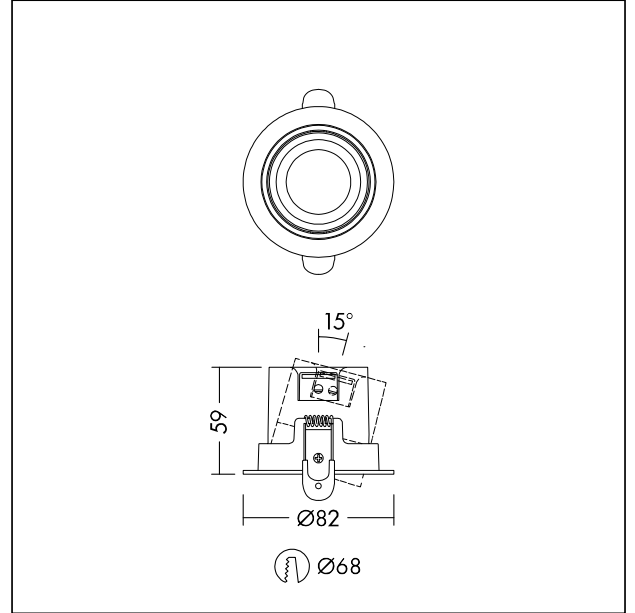

TE_LILY_F_tilted_trim_persp.jpg



TE_LILY_M_SPOT_STD.wmf

Light Distribution

STD - standard

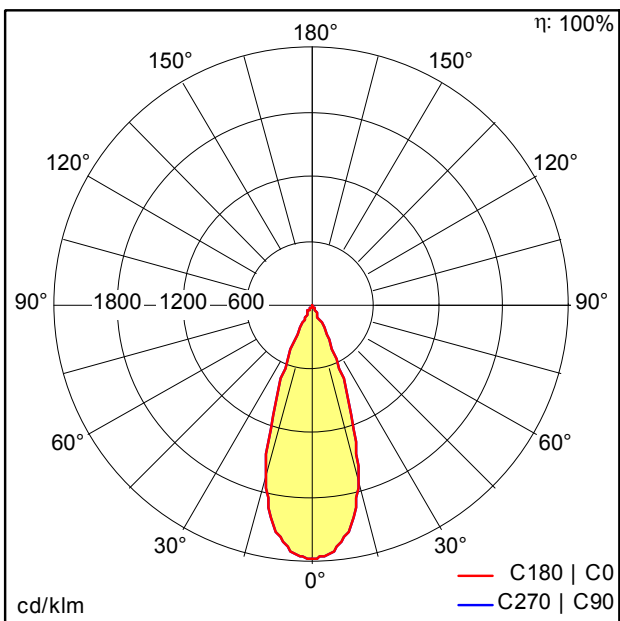

TE_LILY_LED_SPOT_IP44_38_68_850_940_ADJ_WH.Idt

- Light Source: LED
- Luminaire luminous flux*: 900 lm
- Luminaire efficacy*: 100 lm/W
- Colour Rendering Index min.: 90
- Correlated colour temperature: 4000 Kelvin
- Chromaticity tolerance (initial MacAdam): 3
- Rated median useful life*:
L80 50000h at 25°C
- Ballast: 1x LED_Con
- Luminaire input power*: 9 W Power factor = 0.9
- Dimming: PCDCG dimmable to 10%

All values marked with an * are rated values. Luminous flux and connected electrical load are subject to an initial tolerance of +/- 10%. Unless stated otherwise, the values apply to an ambient temperature of 25°C.