

Wall mounted luminaire

Circular IP66 bulkhead with switchable colour temperature: choose between warm white (3000K) and neutral white (4000K) to suit application use. High colour rendering and uniform light surface with no shadowing. Direct replacement for 2x 18W CFL. More than 50% energy savings compared with luminaires with CFL lamps. Frosted diffuser ensures a homogeneous light effect and visual comfort. Piano key terminal for wires up to 2.5mm². Integrated microwave presence sensor maximizing the energy saving potential. Shock resistance degree:IK10

Body: white (RAL 9010), Polycarbonate (UV stabilised).

Diffuser: opal, Polycarbonate (UV stabilised).

Weight: 0,8 kg



TE_TOM_F_2nd_300_WHM.jpg

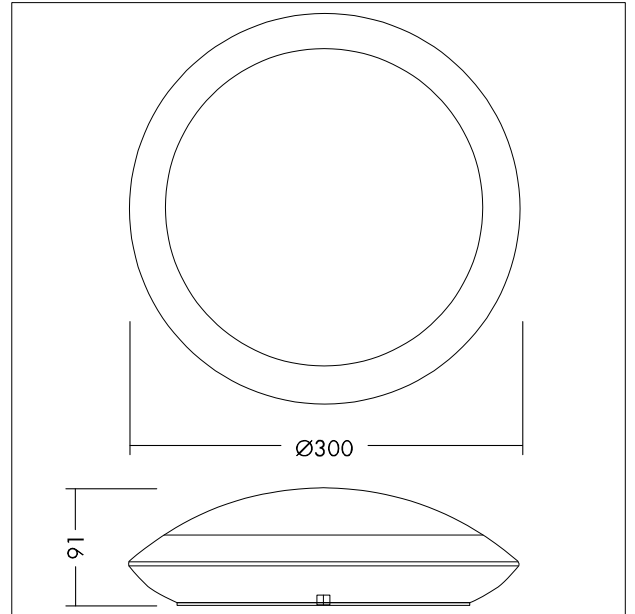

TE_TOML_M_LD2.wmf

Light Distribution

4000 K

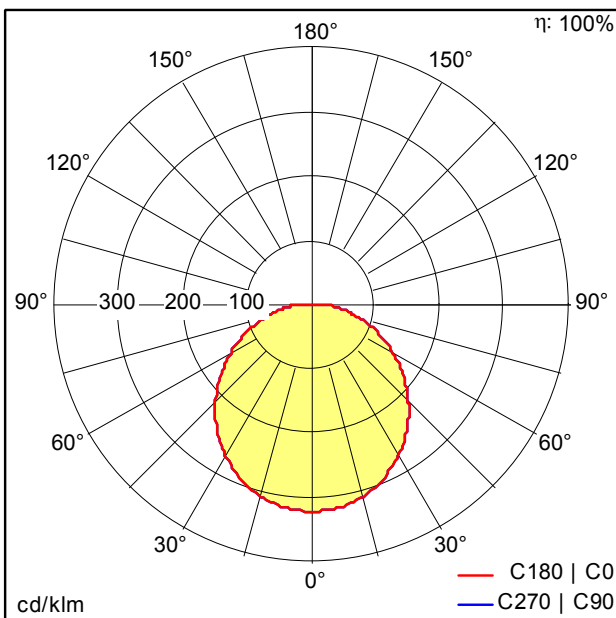

TE_TOM_VARIO_LED_300_1200_840_MWS_WH.Idt

- Light Source: LED
- Luminaire luminous flux*: 1201 lm
- Luminaire efficacy*: 86 lm/W
- Colour Rendering Index min.: 80
- Correlated colour temperature: 4000 Kelvin
- Chromaticity tolerance (initial MacAdam): 6
- Rated median useful life*: L70 50000h at 25°C
- Ballast: 1x LED_Con
- Luminaire input power*: 14 W Power factor = 0.9
- Dimming: Fixed output
- Total harmonic distortion (THD): 30.00 %

This product contains a light source of energy efficiency class E.

All values marked with an * are rated values. Luminous flux and connected electrical load are subject to an initial tolerance of +/- 10%. Unless stated otherwise, the values apply to an ambient temperature of 25°C.