

Abdeckring, gewölbt

Gewölbter Ring für LARA LED 250.

Material: PC, chrome.

Gewicht 0,2 kg.



TE_LARA_F_300_CURVED_BEZEL_TRIM_ACCESSOR_CHR.jpg

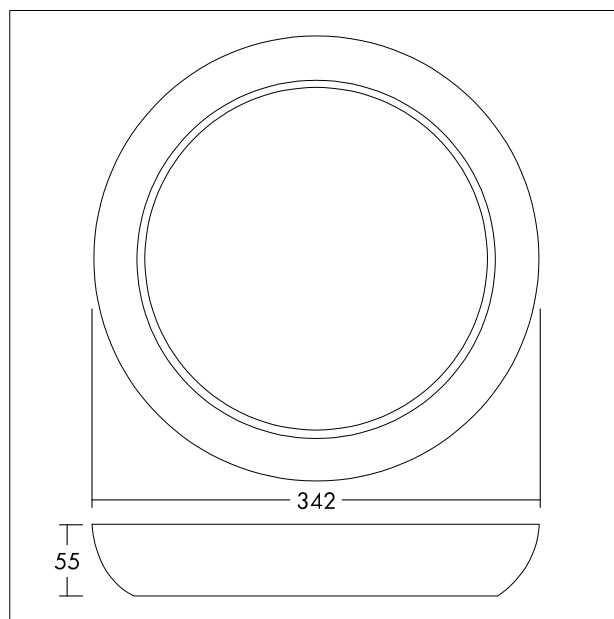

TE_LARA_M_300_CURVED_BEZEL_TRIM.wmf

Lichtverteilung

STD - Standard