

## Abdeckring, gewölbt

Gewölbter Ring für LARA LED 250.

Material: PC, weiß (RAL 9003).

Gewicht 0,2 kg.



TE\_LARA\_F\_300\_CURVED\_BEZEL\_TRIM\_ACCESSOR\_WH.jpg

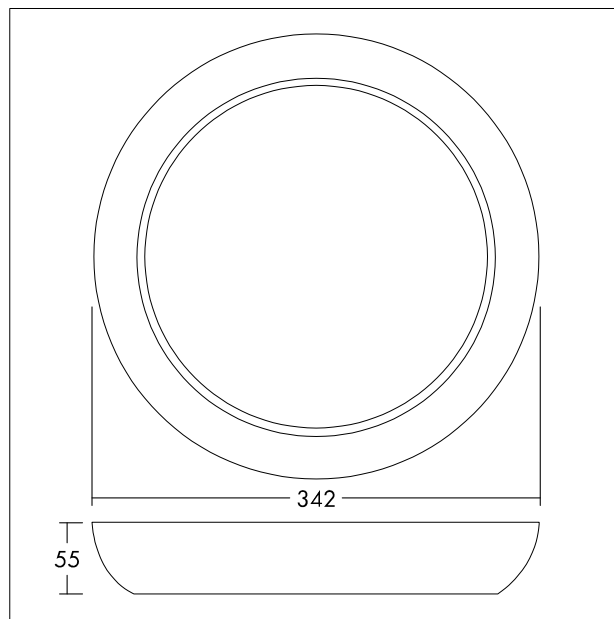

TE\_LARA\_M\_300\_CURVED\_BEZEL\_TRIM.wmf

## Lichtverteilung

STD - Standard