

Recessed LED panel

Recessed LED panel UGR<19. Elegant and timeless design with slim metal frame of only 8.5mm depth. Opal diffuser with fully homogenous illumination. Even surface UGR<19: gentle, soft and glare-free lighting for office applications. Tool-free installation (piano key terminal for up to 2.5 mm² wires). External connector box enabling loop-in loop-out wiring. Flicker free. Replaces conventional luminaires with 2 x 36 W T8 and offers up to 40 % energy saving. Suitable for lay-in installation, suspension and surface mounting. THD≤20%.

Frame: Aluminium

Diffuser: TpB rated PET-diffuser, opal

Light guide plate: PS

Backplate: metal, white (RAL 9003)

Weight: 2.68 kg

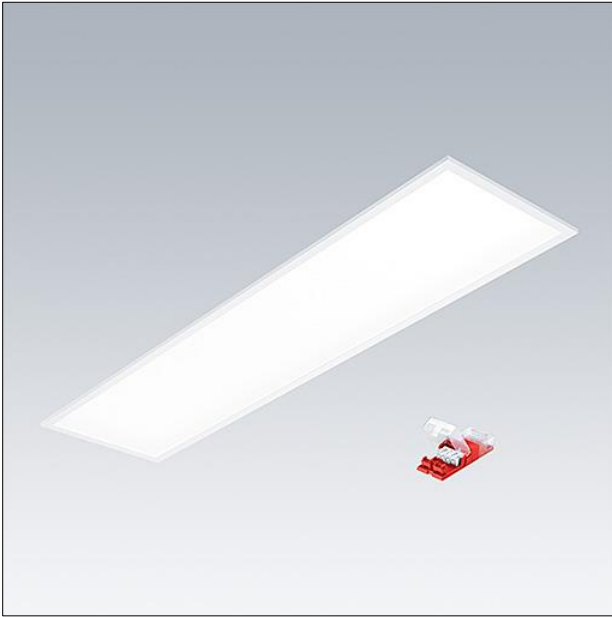

TE_ANNA_F_1200x300_persp.jpg

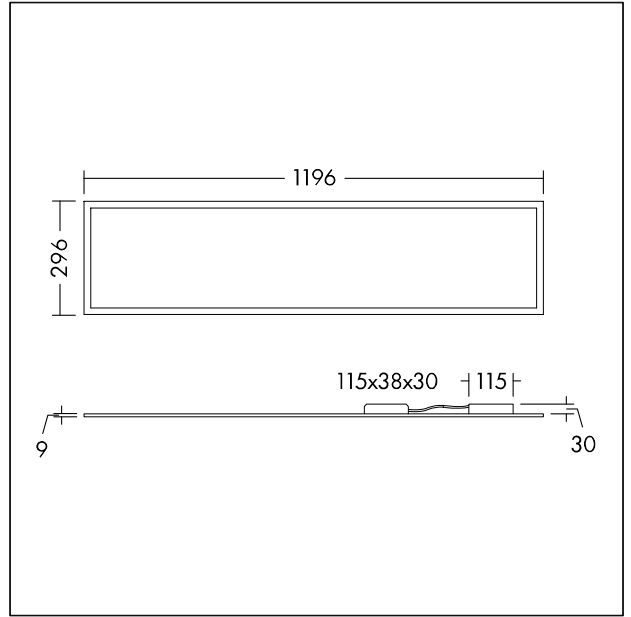

TE_ANNA_M_1200.wmf

Light Distribution

STD - standard

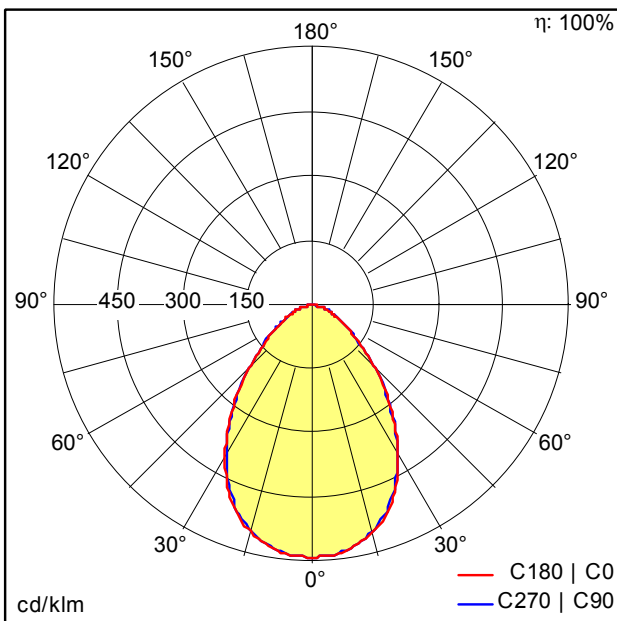

TE_ANNA_LED_1200x300_3800_830.idt

- Light Source: LED
- Luminaire luminous flux*: 3804 lm
- Luminaire efficacy*: 95 lm/W
- Colour Rendering Index min.: 80
- Correlated colour temperature*: 3000 Kelvin
- Chromaticity tolerance (initial MacAdam)*: 4
- Rated median useful life*: 50000h L70 at 25°C
- Ballast: 1x LED_Con
- Luminaire input power*: 40 W Power factor = 0.9
- Dimming: Fixed output