

LED Floodlight

Very lightweight, compact and streamline design. Universal mounting bracket allows wall or surface mounting with the possibility of tilting upwards or downwards. Suitable to use with the "LEONIE PLUG&PLAY MWS" presence sensor (available as accessory). Pre-wired with mains cable.

Body: Aluminium die-cast (<5% copper)

Bracket: Steel, gray (RAL 9006)

Cover: Tempered glass

Lens: PC

Weight: 0,53 kg



TE_LEONIE_F_30.jpg

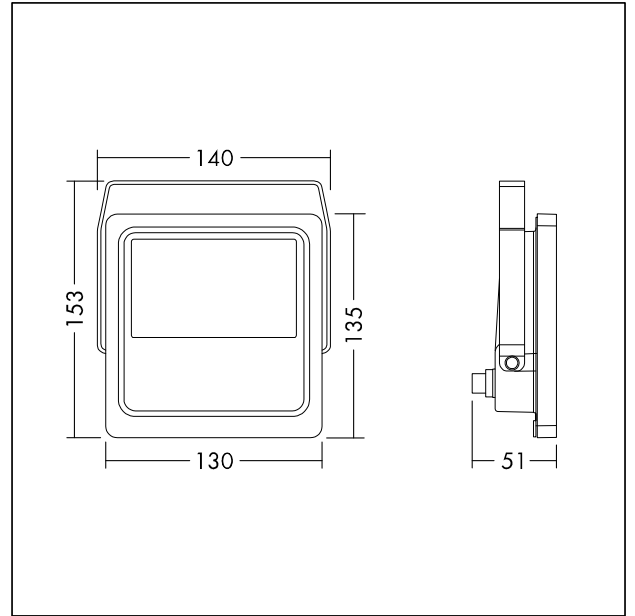

TE_LEONIE_M_30.wmf

Light Distribution

STD - standard

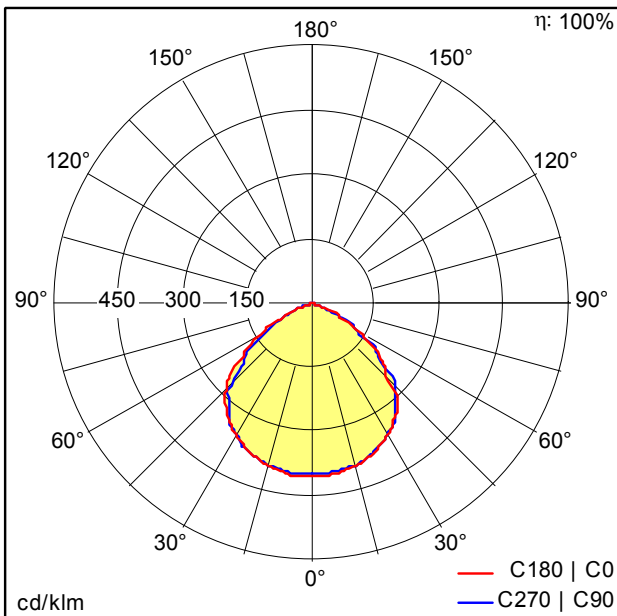

TE_LEONIE_LED_FL_IP65_30W_830.idt

- Light Source: LED
- Luminaire luminous flux*: 3000 lm
- Luminaire efficacy*: 100 lm/W
- Colour Rendering Index min.: 80
- Correlated colour temperature: 3000 Kelvin
- Chromaticity tolerance (initial MacAdam): 5
- Rated median useful life*:
L70 50000h at 25°C
- Ballast: 1x LED_Con
- Luminaire input power*: 30 W Power factor = 0.9
- Dimming: Fixed output

All values marked with an * are rated values. Luminous flux and connected electrical load are subject to an initial tolerance of +/- 10%. Unless stated otherwise, the values apply to an ambient temperature of 25°C.