

LED Floodlight

Very lightweight, compact and streamline design. Universal mounting bracket allows wall or surface mounting with the possibility of tilting upwards or downwards. Suitable to use with the "LEONIE PLUG&PLAY MWS" presence sensor (available as accessory). Pre-wired with mains cable.

Body: Aluminium die-cast (<5% copper)

Bracket: Steel, gray (RAL 9006)

Cover: Tempered glass

Lens: PC

Weight: 0,53 kg



TE_LEONIE_F_30.jpg

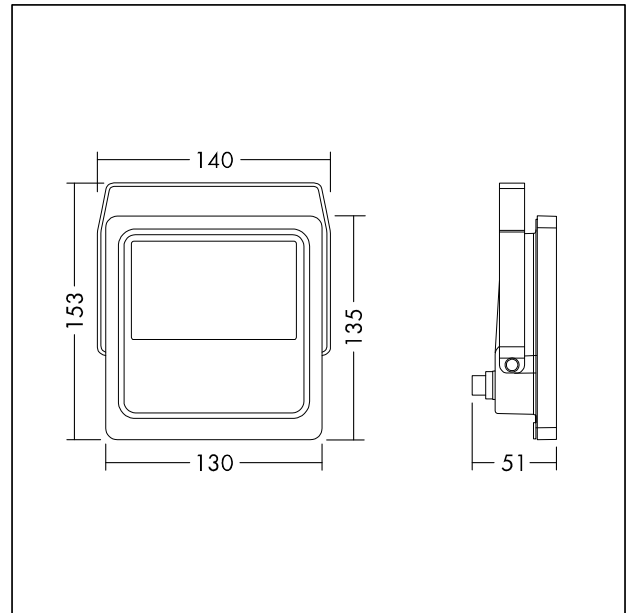

TE_LEONIE_M_30.wmf

Light Distribution

STD - standard

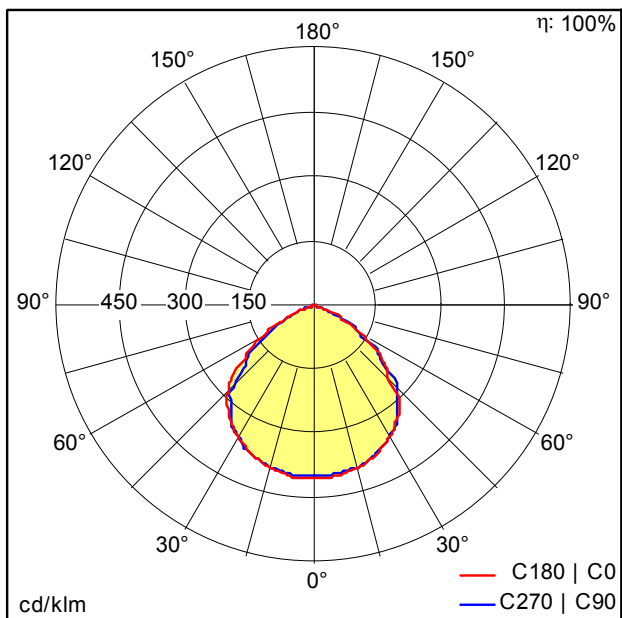

TE_LEONIE_LED_FL_IP65_30W_840.idt

- Light Source: LED
- Luminaire luminous flux*: 2700 lm
- Luminaire efficacy*: 90 lm/W
- Colour Rendering Index min.: 80
- Correlated colour temperature*: 4000 Kelvin
- Chromaticity tolerance (initial MacAdam)*: 5
- Rated median useful life*: 50000h L70 at 25°C
- Ballast: 1x LED_Con
- Luminaire input power*: 30 W Power factor = 0.9
- Dimming: Fixed output