

IP66 Surface mounted LED luminaire

An IP66 rated LED luminaire for high quality low energy lighting in wet and dusty environments with opal diffuser for uniform lighting. Through-wired: equipped with two 3-pole push-terminals (N, earth, L) as standard. Easy, quick and tool-free installation thanks to the twist & lock mechanism in the end caps, which gives access to the push terminals. Flexible installation as mounting brackets can be positioned freely on the luminaire. High efficacy, up to 60% energy saving compared with T8 fluorescent.

Body: Polycarbonate, white

Diffuser: Opal, polycarbonate

End caps: Polycarbonate, white

Brackets: Stainless steel

Weight: 1,4 kg



TE_LUCY_F_detail_03.jpg

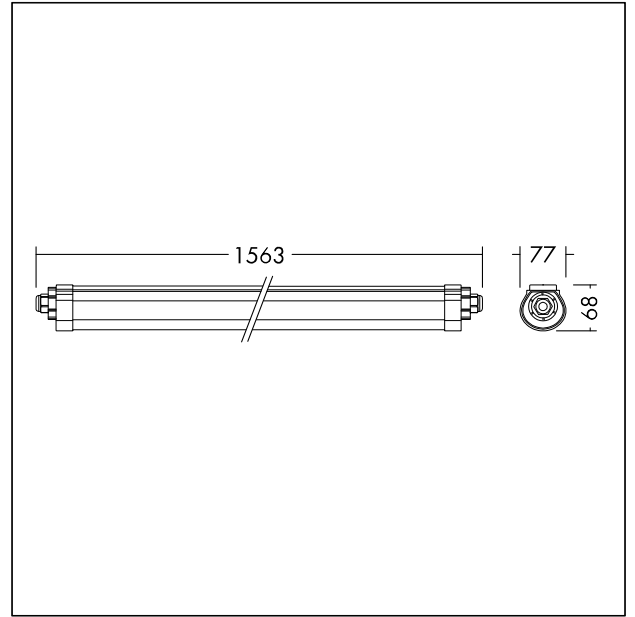

TE_LUCY_M_1500.wmf

Light Distribution

STD - standard

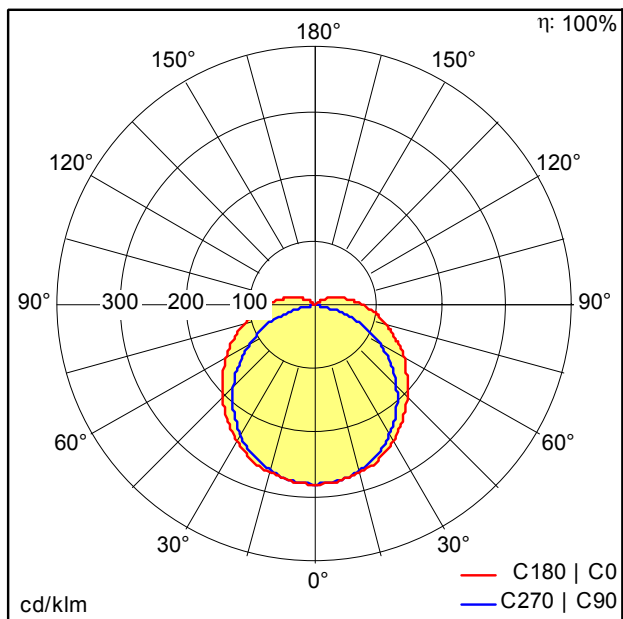

TE_LUCY_1500_LED_IP66_6000_840_TW.Idt

- Light Source: LED
- Luminaire luminous flux*: 6000 lm
- Luminaire efficacy*: 100 lm/W
- Colour Rendering Index min.: 80
- Correlated colour temperature*: 4000 Kelvin
- Chromaticity tolerance (initial MacAdam)*: 4
- Rated median useful life*: 50000h L70 at 25°C
- Ballast: 1x LED_Con
- Luminaire input power*: 60 W Power factor = 0.9
- Dimming: Fixed output