

LED high-bay luminaire

An IP65 single point suspension LED high bay luminaire. Offers a simple, direct and cost-effective one-for-one replacement of traditional HID high bay luminaires. Efficient LEDs (120 lm/W) combined with a lens technology offering UGR<25 and a beam angle of 65° to reduce waste light. The housing is carefully designed to allow air flow cooling of the luminaire to prevent the components from overheating and ensures optimum performance in industrial environments. Surge protection up to 4kV. Pre-wired with mains cable (150 mm)+connector.

Body: Aluminum die-cast, black (RAL 9017)

Lense: PC

Weight: 3.4 kg



TE_GEOR_F_LED_330_persp.jpg

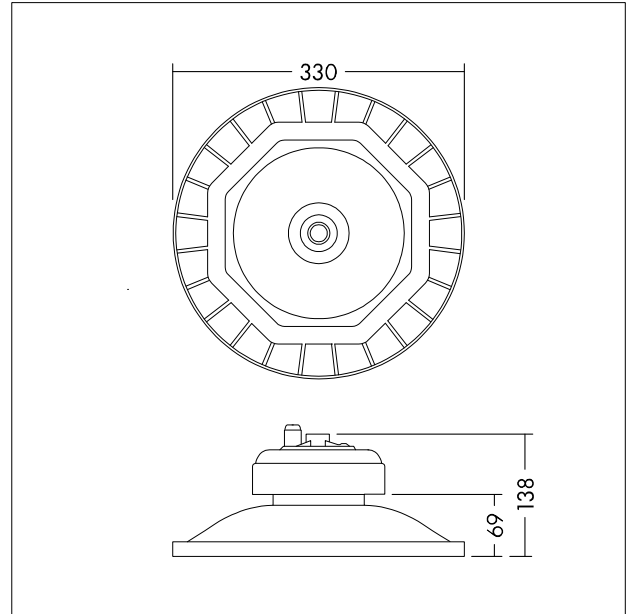

TE_GEOR_M_LED_330.wmf

Light Distribution

STD - standard

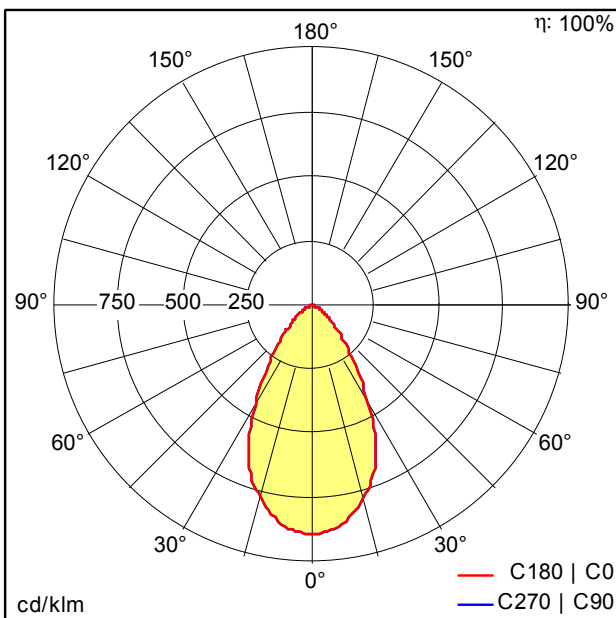

TE_GEORGE_LED_330_12000_840.idt

- Light Source: LED
- Luminaire luminous flux*: 12000 lm
- Luminaire efficacy*: 120 lm/W
- Colour Rendering Index min.: 80
- Correlated colour temperature: 4000 Kelvin
- Chromaticity tolerance (initial MacAdam): 5
- Rated median useful life*: L70 50000h at 25°C
- Ballast: 1x LED_Con
- Luminaire input power*: 100 W Power factor = 0.9
- Dimming: Fixed output

All values marked with an * are rated values. Unless stated otherwise, the values apply to an ambient temperature of 25°C.