

Wall mounted luminaire

Circular IP65 bulkhead with optional trim accessories. Direct replacement for 1x16W 2D. More than 50% energy savings compared with luminaires with CFL lamps. Frosted diffuser ensuring homogeneous light effect and visual comfort. Sealed to IP65 for protected exterior applications. Robust construction tested up to IK08 impact resistance. Integral photocell.

Body: Polycarbonate, black (RAL 9011)

Diffuser: Polycarbonate, opal

Weight: 0.71 kg



TE_LARA_F_250_BLANK_BL_persp.jpg

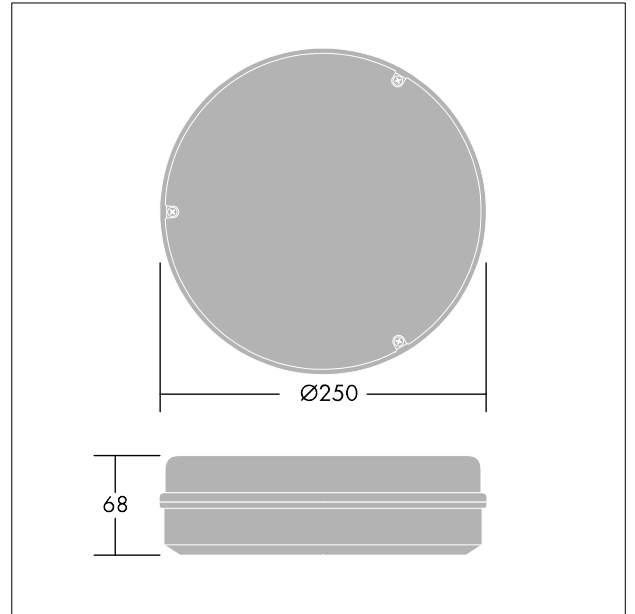

TE_LARA_M_800L.wmf

Light Distribution

STD - standard

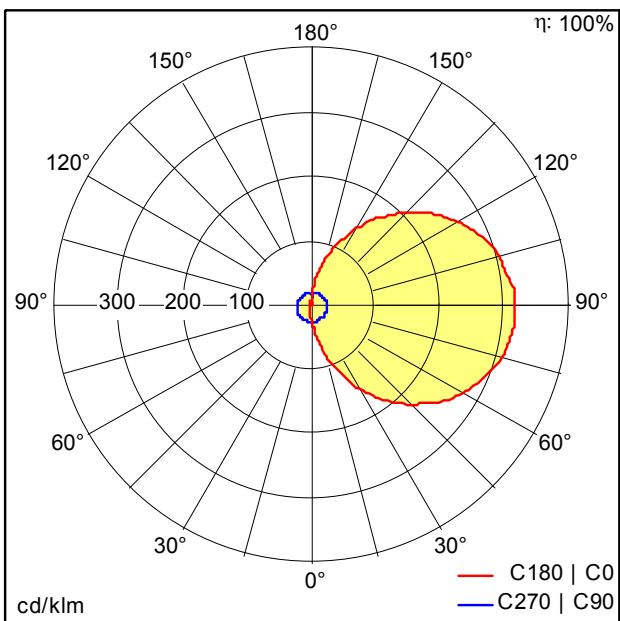

TE_LARA_LED_250_800_840_PC_BLK.Idt

- Light Source: LED
- Luminaire luminous flux*: 799 lm
- Luminaire efficacy*: 80 lm/W
- Colour Rendering Index min.: 80
- Correlated colour temperature*: 4000 Kelvin
- Chromaticity tolerance (initial MacAdam)*: 4
- Rated median useful life*: 50000h L70 at 25°C
- Ballast: 1x LED_Con
- Luminaire input power*: 10 W Power factor = 0.55
- Dimming: Fixed output