

Wall mounted luminaire

Circular IP65 bulkhead with optional trim accessories. Direct replacement for 1x16W 2D. More than 40% energy savings compared with luminaires with CFL lamps. Frosted diffuser ensuring homogeneous light effect and visual comfort. Sealed to IP65 for protected exterior applications. Robust construction tested up to IK08 impact resistance.

Body: Polycarbonate, white (RAL 9003)

Diffuser: Polycarbonate, opal

Weight: 0.71 kg



TE_LARA_F_250_BLANK_WH_persp.jpg

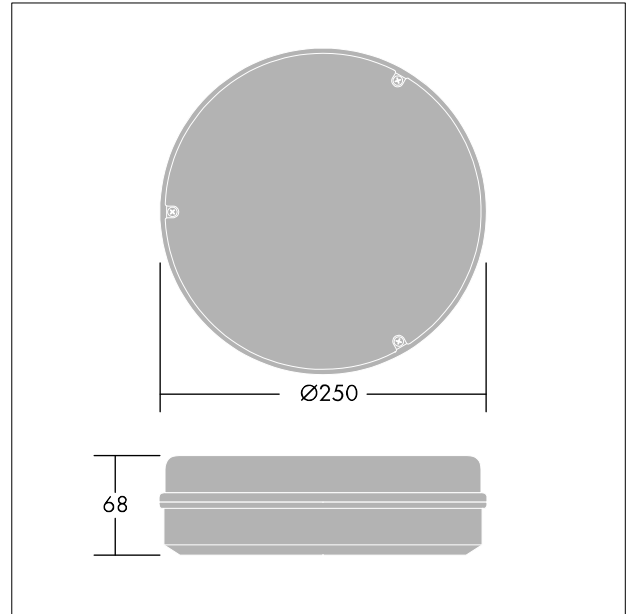

TE_LARA_M_800L.wmf

Light Distribution

STD - standard

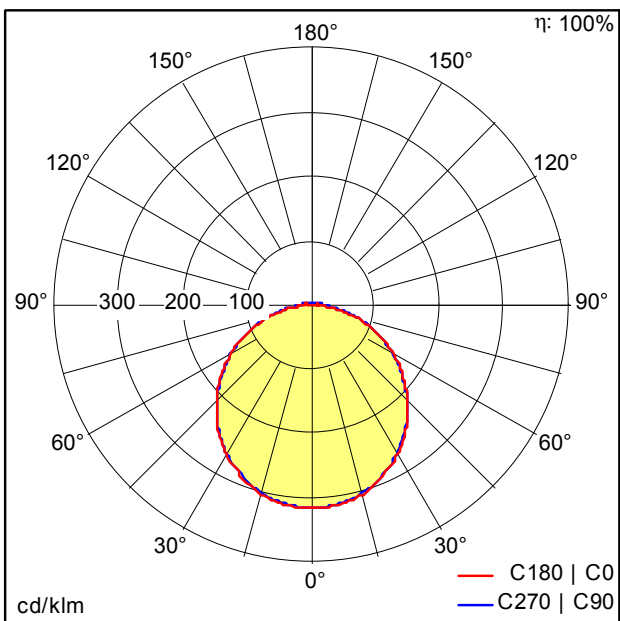

TE_LARA_LED_250_800_840_WH.Idt

- Light Source: LED
- Luminaire luminous flux*: 800 lm
- Luminaire efficacy*: 80 lm/W
- Colour Rendering Index min.: 80
- Correlated colour temperature: 4000 Kelvin
- Chromaticity tolerance (initial MacAdam): 4
- Rated median useful life*:
L70 50000h at 25°C
- Ballast: 1x LED_Con
- Luminaire input power*: 10 W Power factor = 0.55
- Dimming: Fixed output

All values marked with an * are rated values. Luminous flux and connected electrical load are subject to an initial tolerance of +/- 10%. Unless stated otherwise, the values apply to an ambient temperature of 25°C.