

LED ceiling-recessed luminaire

Recessed LED downlight, one for one replacement for traditional 2x18W compact fluorescent downlights. Consistent light output with no shadowing. High efficacy, up to 80% energy saving compared with fluorescent light sources. 150mm cut-out – identical to traditional products. AMY LED can be installed into a wide range of ceiling types of 2-20 mm thickness. 3h emergency light. THD<25%.

Body: Aluminium white finish (RAL 9003)
 Diffuser: Polycarbonate (TPb construction)
 Weight: 1.9 kg



TE_AMY_F_E3_150_side.jpg

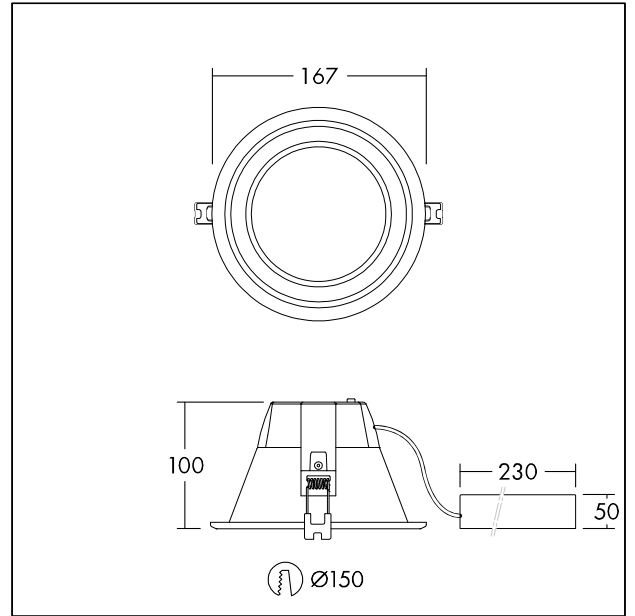

TE_AMY_M_E3_MED.wmf

Light Distribution

Emergency

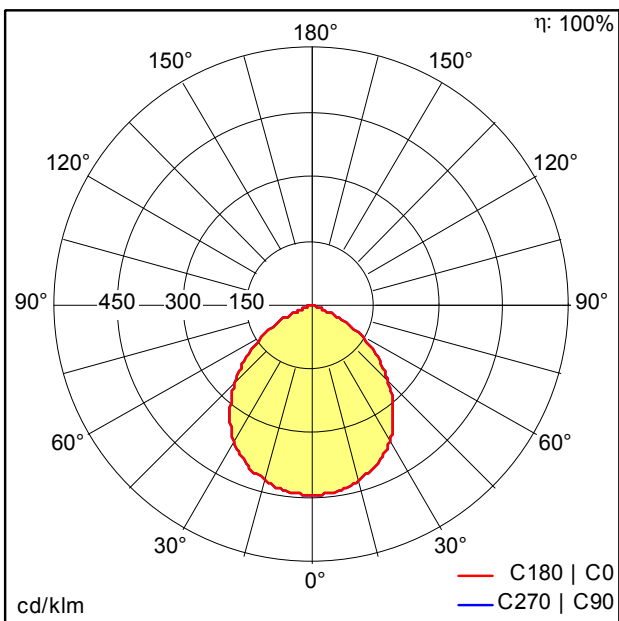

TE_AMY_150_LED_DL_1500_830_E3e.ltd

- Light Source: LED
- Luminaire luminous flux*: 344 lm
- Luminaire efficacy*: 172 lm/W
- Colour Rendering Index min.: 80
- Chromaticity tolerance (initial MacAdam)*: 4
- Rated median useful life*: 50000h L70 at 25°C
- Ballast: 1x LED_Con
- Luminaire input power*: 2 W
- Dimming: Fixed output