

LED ceiling-recessed luminaire

Recessed LED downlight, one for one replacement for traditional 1x26W compact fluorescent downlights. Consistent light output with no shadowing. High efficacy, up to 80% energy saving compared with fluorescent light sources. 150mm cut-out – identical to traditional products. AMY LED can be installed into a wide range of ceiling types of 2-20mm thickness. THD<25%.

Body: Aluminium white finish (RAL 9003)  
 Diffuser: Polycarbonate (TPb construction)  
 Weight: 0.3 kg



TE\_AMY\_F\_150\_side.jpg

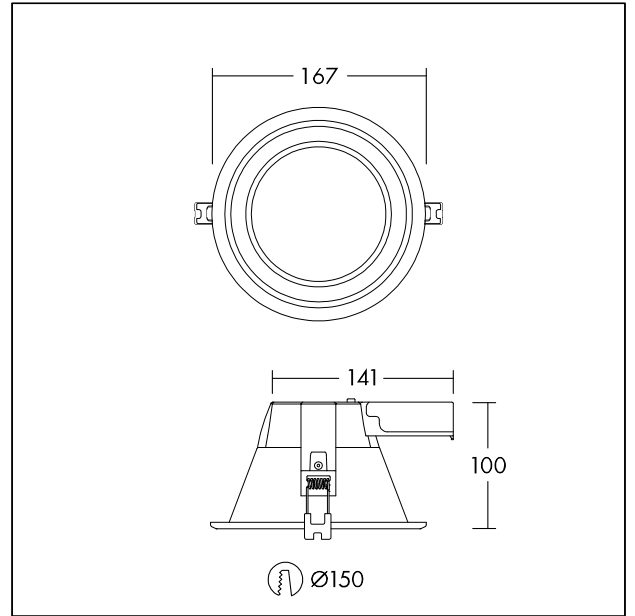

TE\_AMY\_M\_MED.wmf

Light Distribution

STD - standard

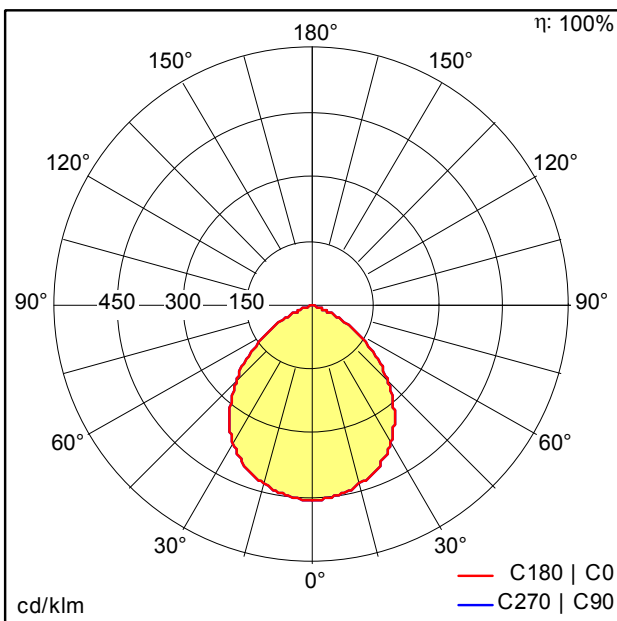

TE\_AMY\_150\_LED\_DL\_1000\_830.idt

- Light Source: LED
- Luminaire luminous flux\*: 1001 lm
- Luminaire efficacy\*: 83 lm/W
- Colour Rendering Index min.: 80
- Correlated colour temperature\*: 3000 Kelvin
- Chromaticity tolerance (initial MacAdam)\*: 4
- Rated median useful life\*: 50000h L70 at 25°C
- Ballast: 1x LED\_Con
- Luminaire input power\*: 12 W Power factor = 0.9
- Dimming: Fixed output