

LED ceiling-recessed luminaire

Recessed LED downlight, one for one replacement for traditional 2x26W compact fluorescent downlights. Consistent light output with no shadowing. High efficacy, up to 80% energy saving compared with fluorescent light sources. 200mm cut-out – identical to traditional products. AMY LED can be installed into a wide range of ceiling types of 2-20mm thickness. THD<25%.

Body: Aluminium white finish (RAL 9003)
 Diffuser: Polycarbonate (TPb construction)
 Weight: 0.36 kg



TE_AMY_F_200_side.jpg

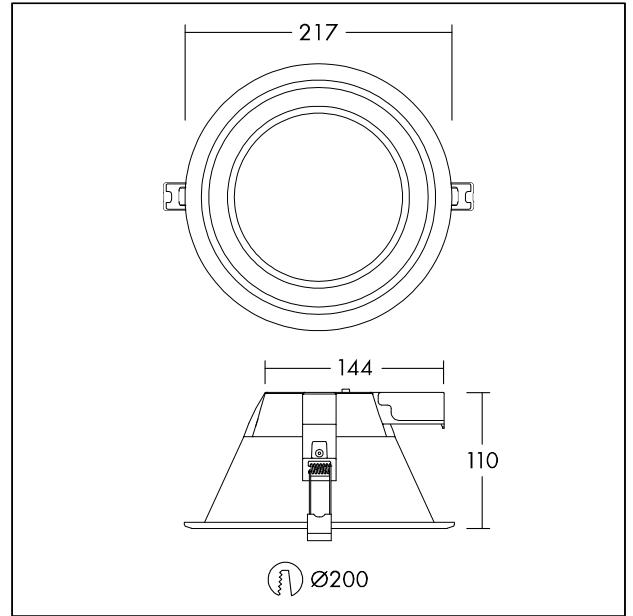

TE_AMY_M_LGE.wmf

Light Distribution

STD - standard

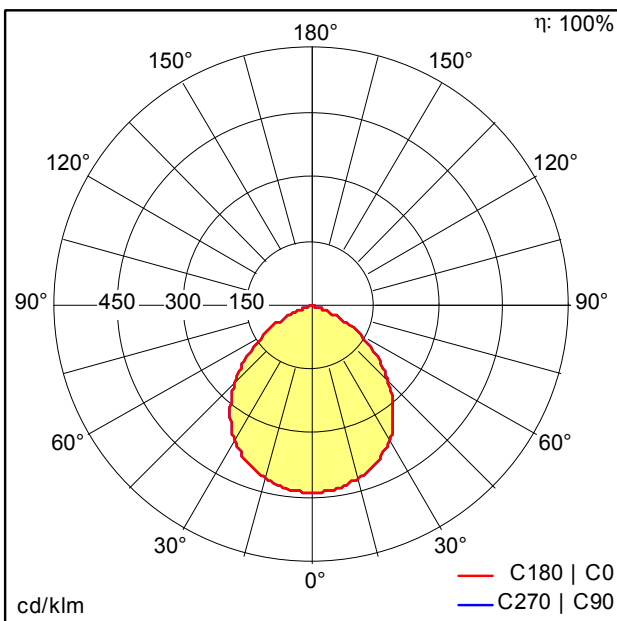

TE_AMY_200_LED_DL_2000_830.idt

- Light Source: LED
- Luminaire luminous flux*: 2002 lm
- Luminaire efficacy*: 95 lm/W
- Colour Rendering Index min.: 80
- Correlated colour temperature*: 3000 Kelvin
- Chromaticity tolerance (initial MacAdam)*: 4
- Rated median useful life*: 50000h L70 at 25°C
- Ballast: 1x LED_Con
- Luminaire input power*: 21 W Power factor = 0.9
- Dimming: Fixed output