

Surface mounted LED luminaire

A compact LED batten with reliability and simple design. High quality diffuser ensures uniform light without visible spots. High efficacy, 40% energy saving compare with T5 fluorescent. The fitting can be mounted individually or continuously (16 pcs of 600mm batten or 8 pcs of 1200mm batten). Supplied with starter lead, mounting kit, connector lead and end cap.

Body and diffuser: dual-color extruded polycarbonate

End-cap: polycarbonate, white

Weight: 0.19 kg



TE_MIKE_F_570_persp.jpg

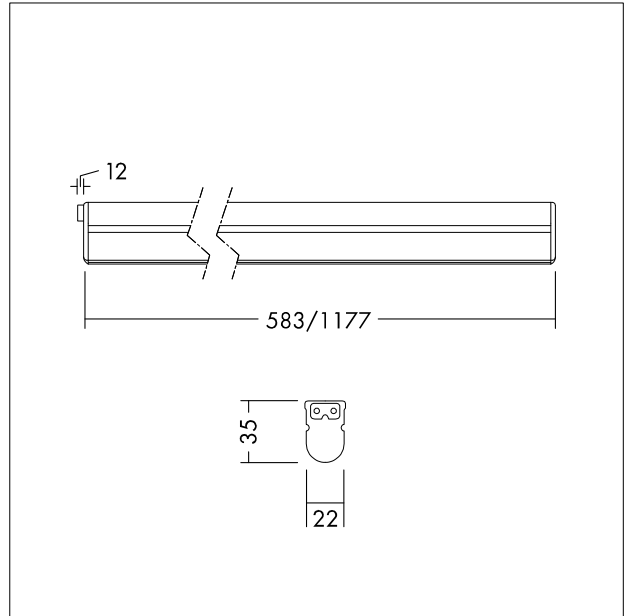

TE_MIKE2_M_LD1.wmf

Light Distribution

STD - standard

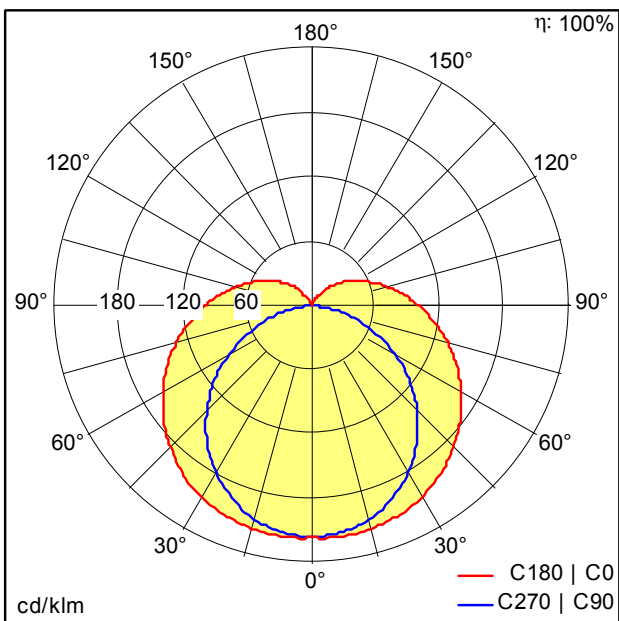

TE_MIKE_LED_583_900_830.idt

- Light Source: LED
- Luminaire luminous flux*: 900 lm
- Luminaire efficacy*: 82 lm/W
- Colour Rendering Index min.: 80
- Correlated colour temperature*: 3000 Kelvin
- Chromaticity tolerance (initial MacAdam)*: 4
- Rated median useful life*: 50000h L70 at 25°C
- Ballast: 1x LED_Con
- Luminaire input power*: 11 W Power factor = 0.9
- Dimming: Fixed output